



Justin Love

FVCP 2014-02-12

# Overview

- Concepts
- Pulling master into branch
- Conflicts
- Pull vs. fetch, merge
- Rebase
- Pull Requests

# Justin Love

[slides@wondible.com](mailto:slides@wondible.com)

<http://wondible.com>

@wondible



# Concepts

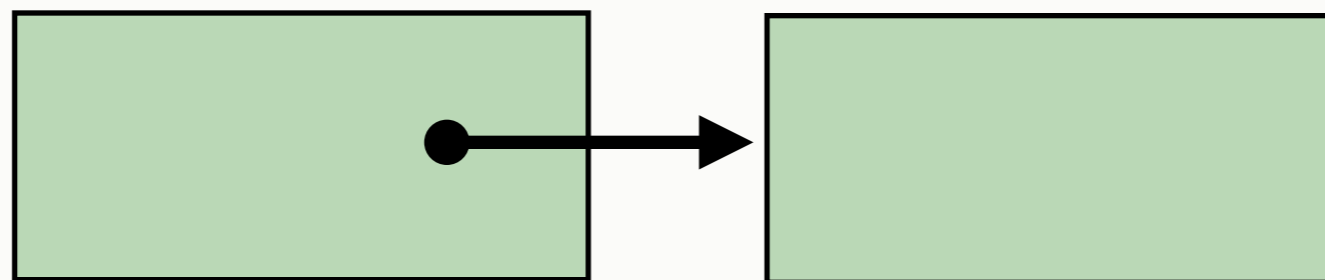

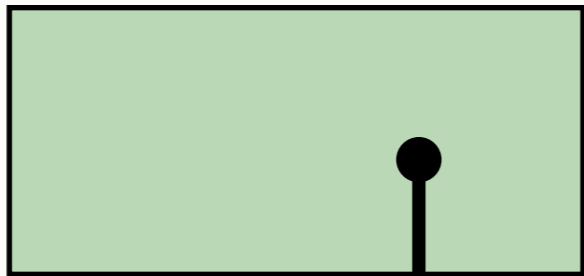

TA	SUBJECT
ec39	pe
6952	se

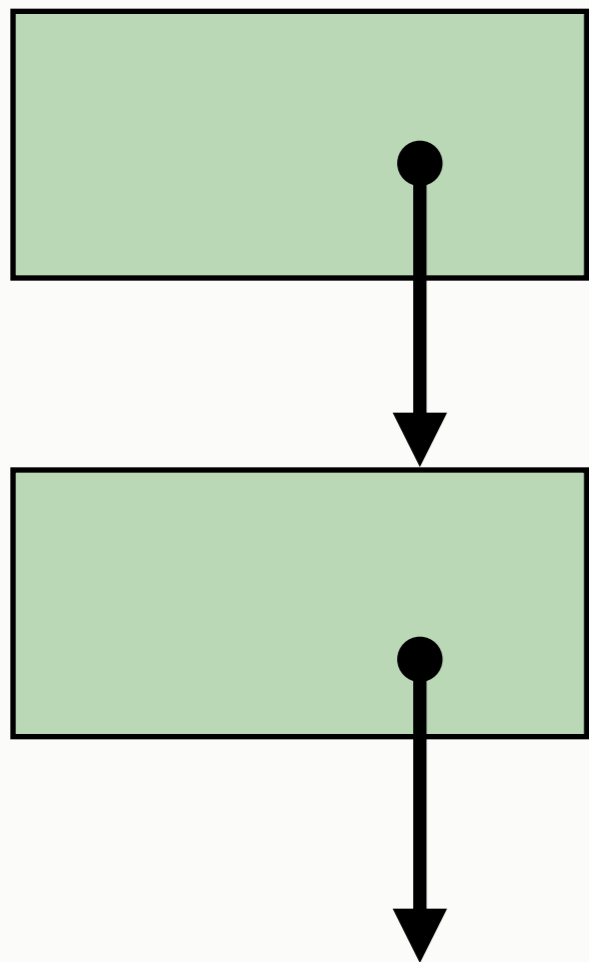

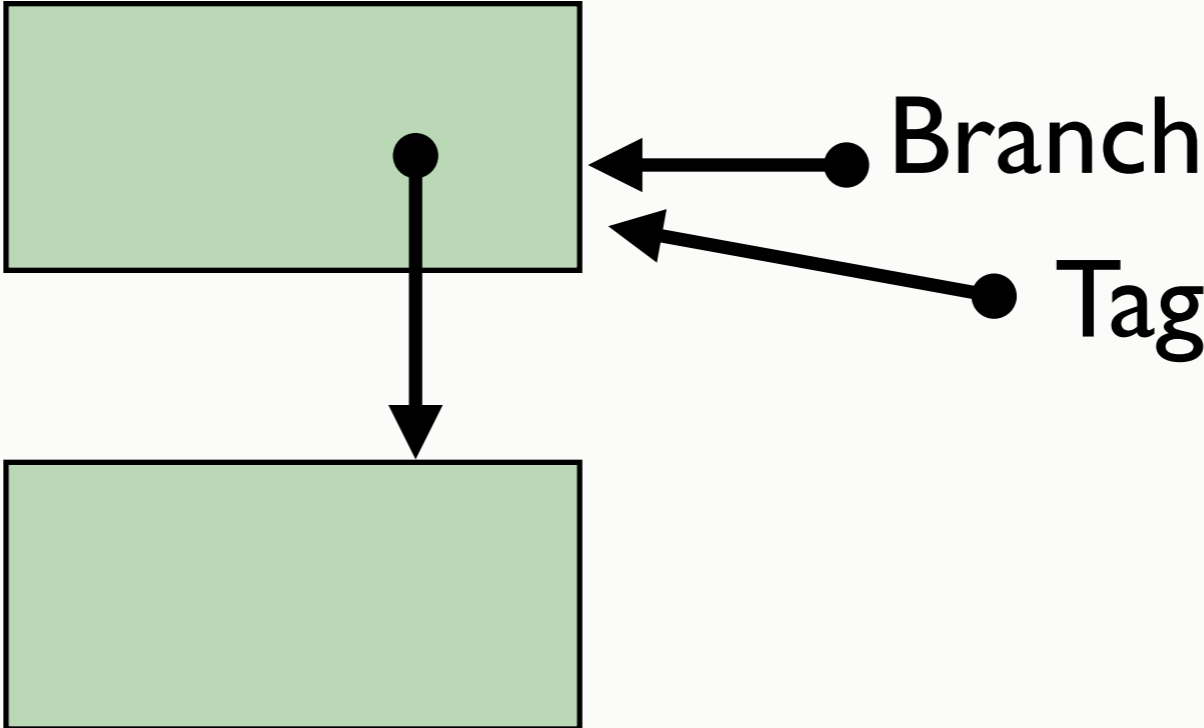



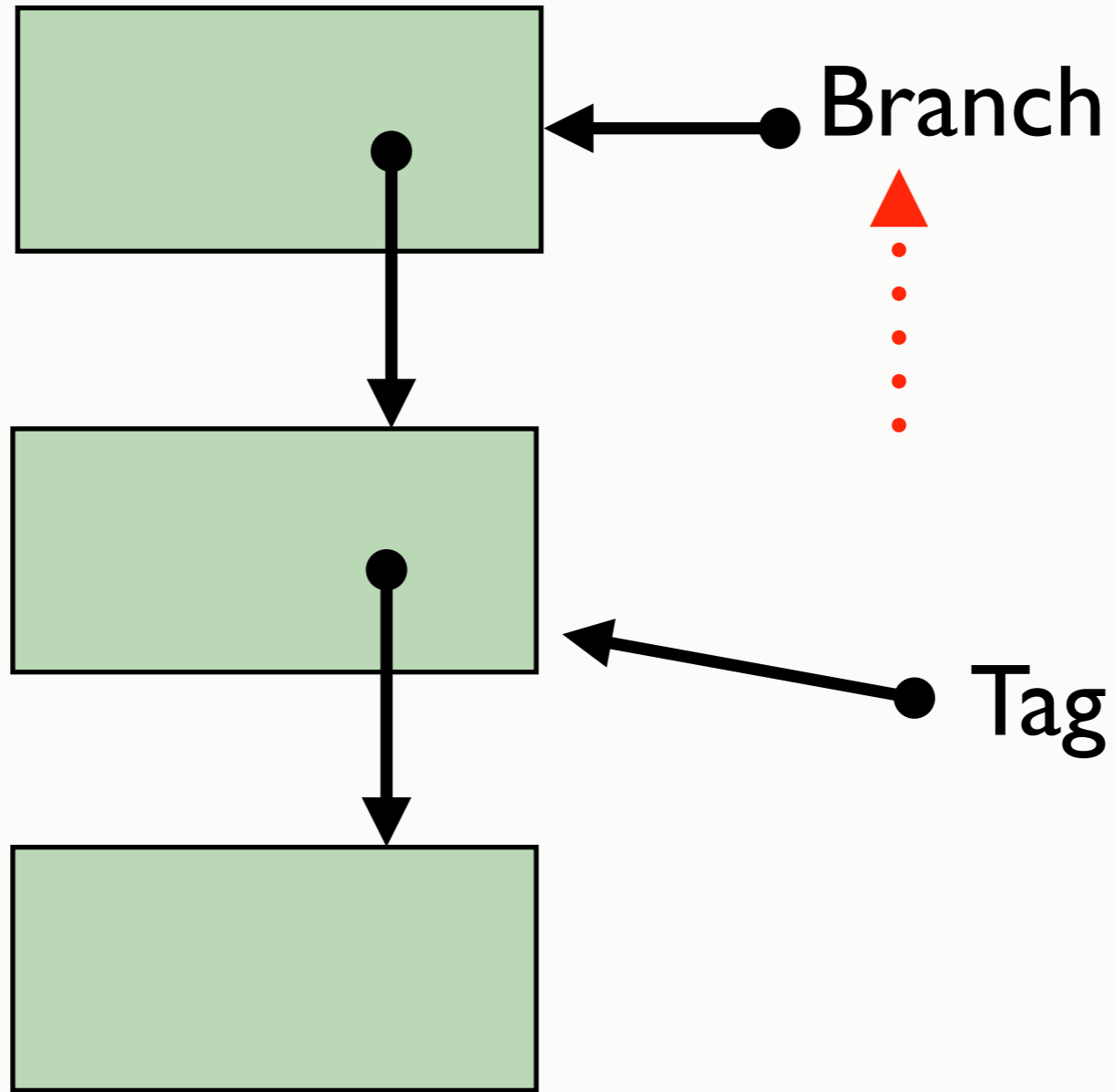

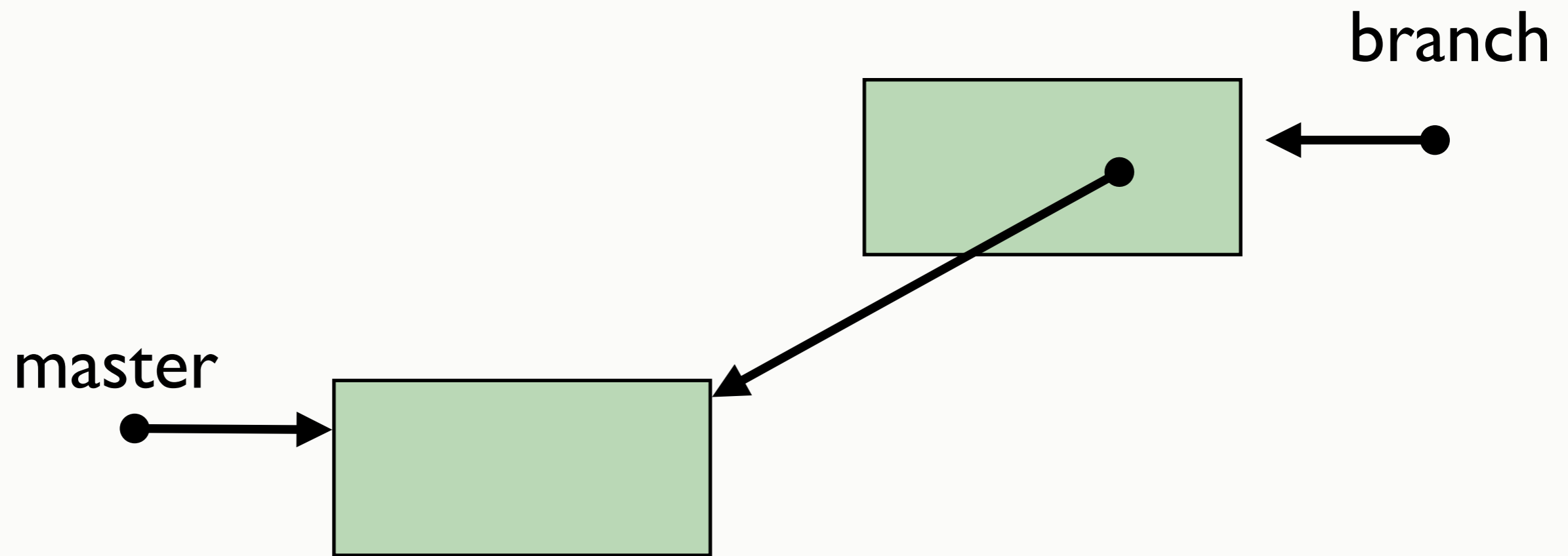

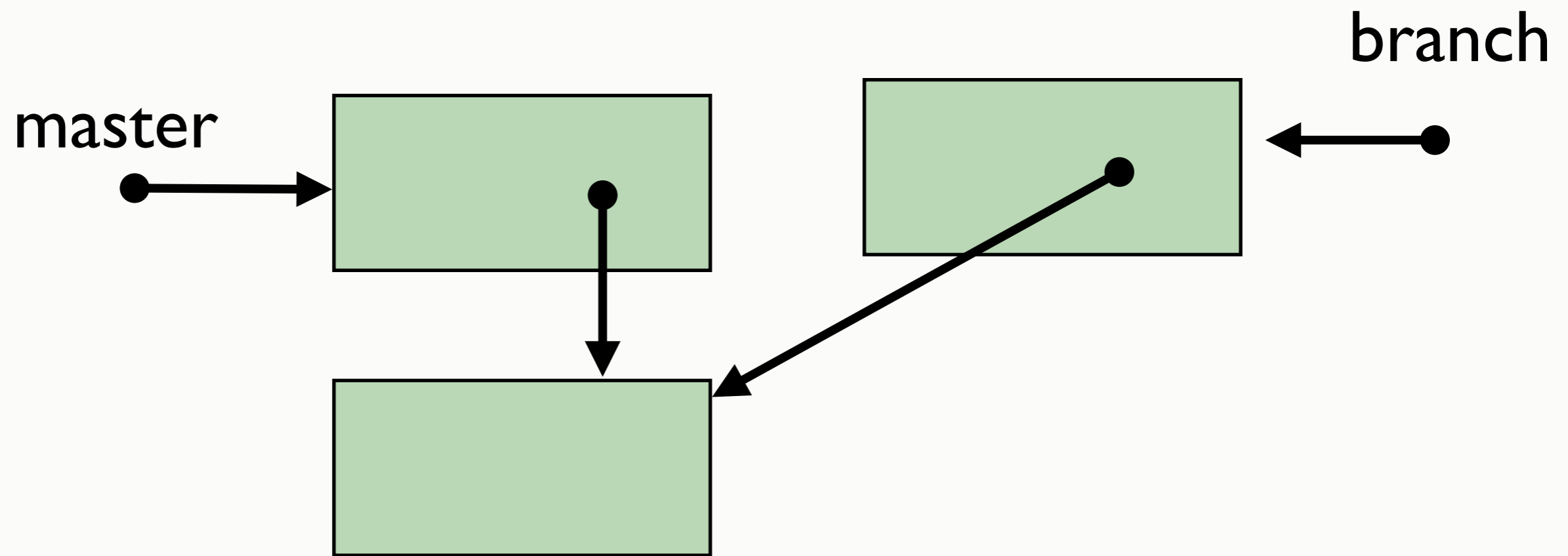

master

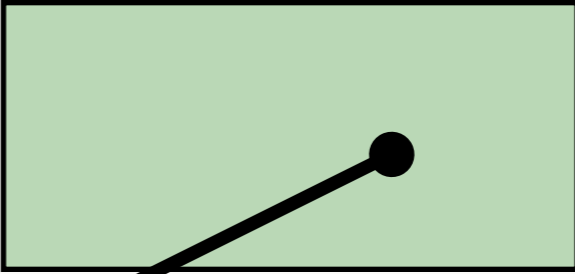
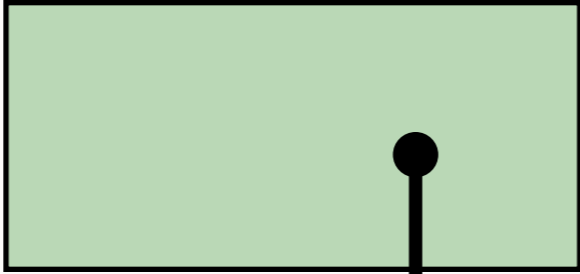
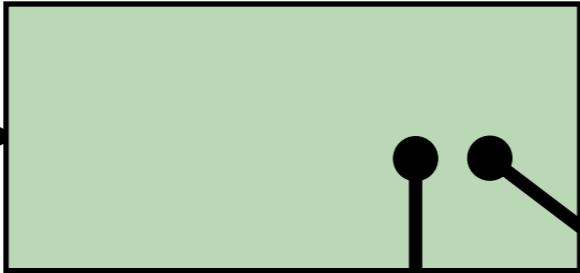

branch

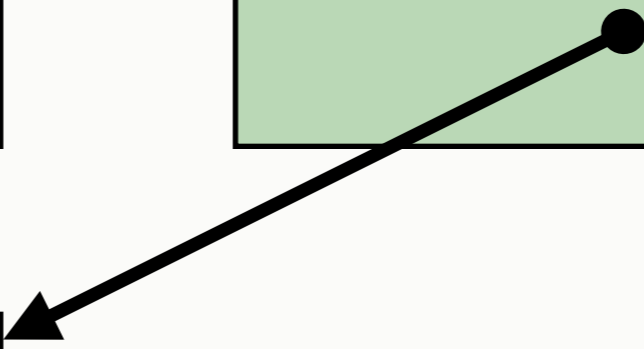

What issues do you  
hit when pulling a  
master branch into  
your working branch?

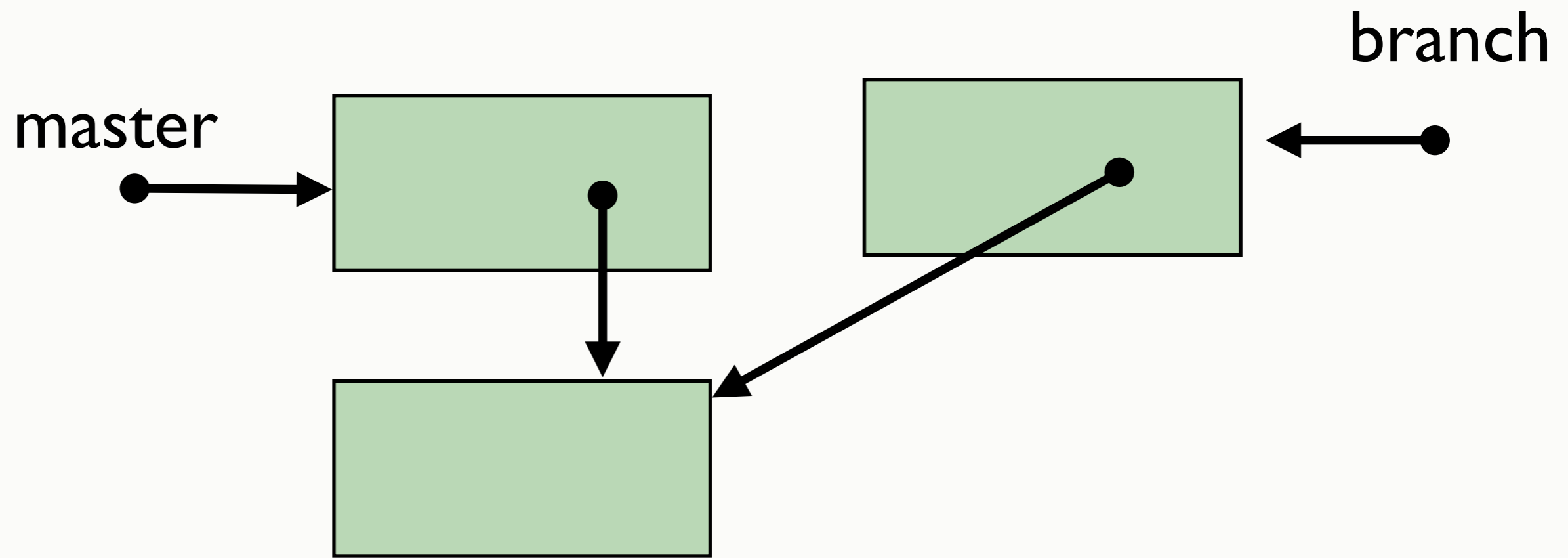

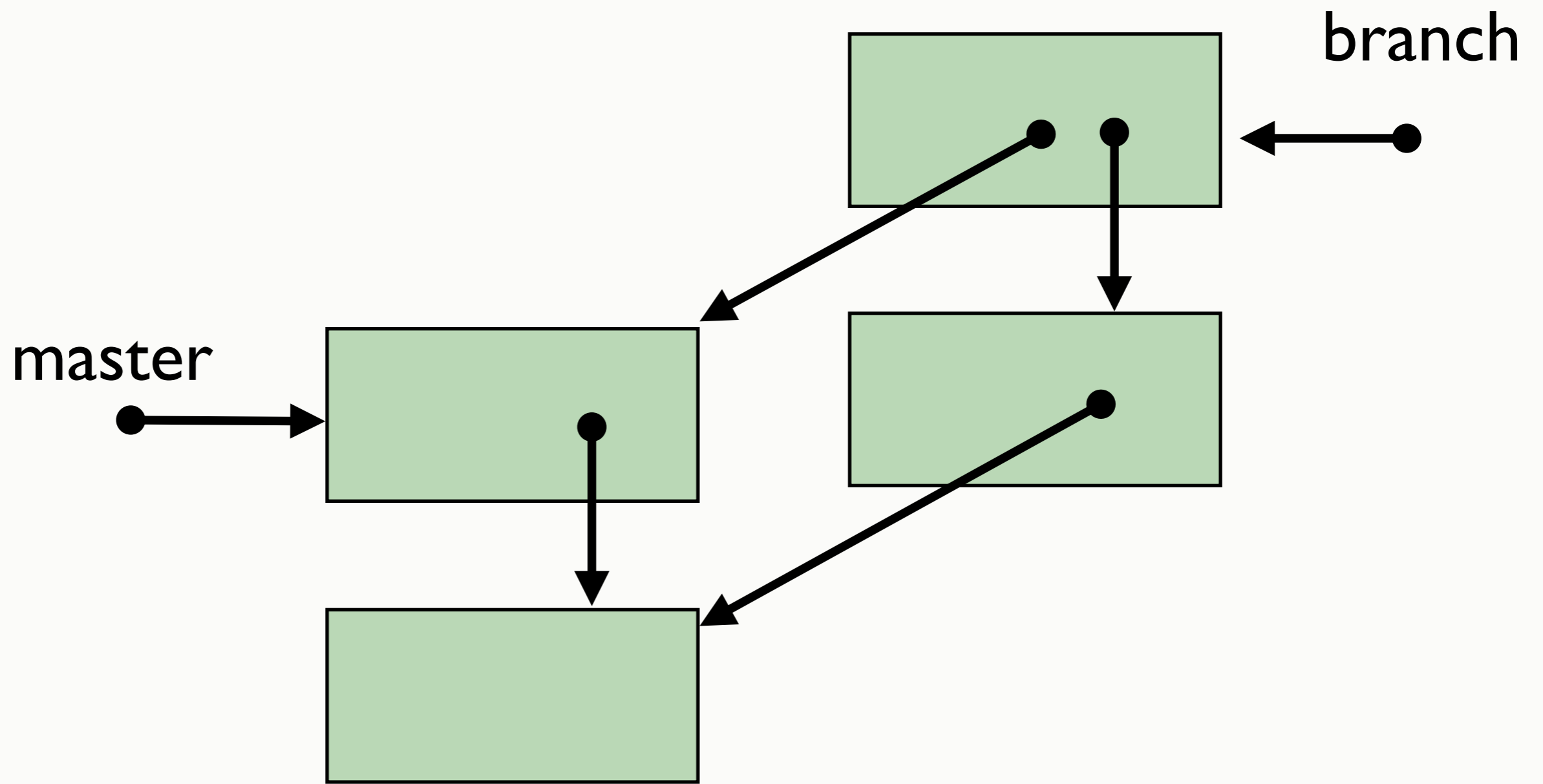

master

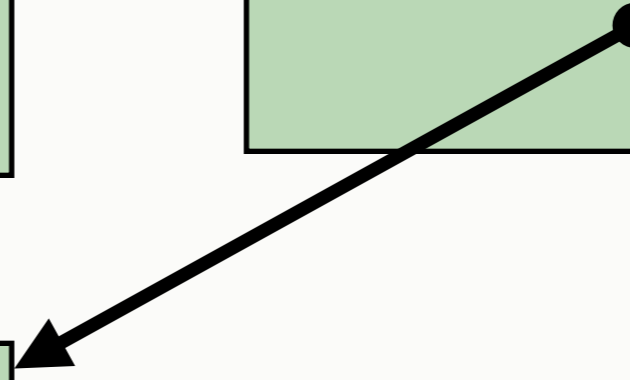
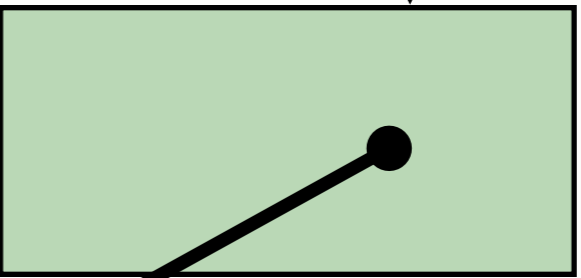
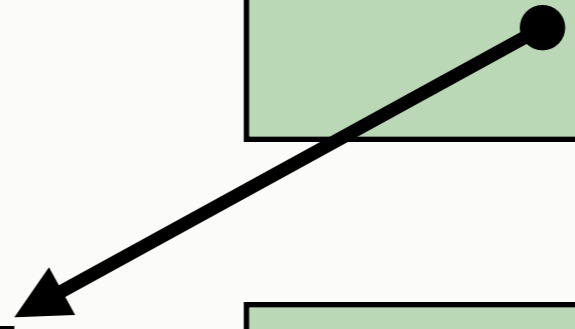
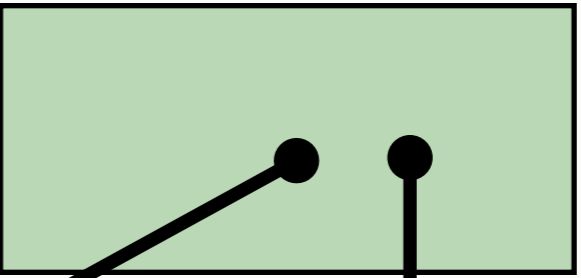
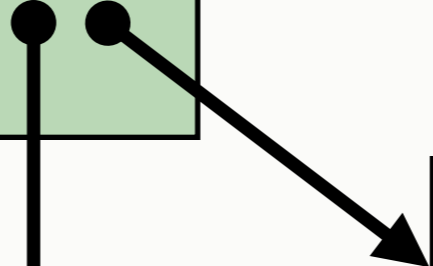
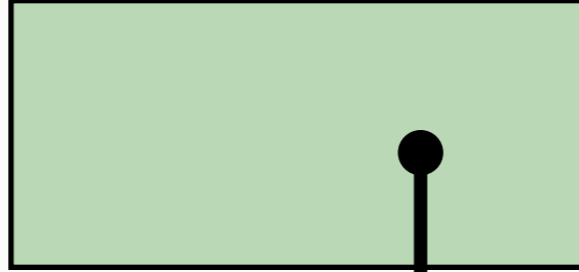
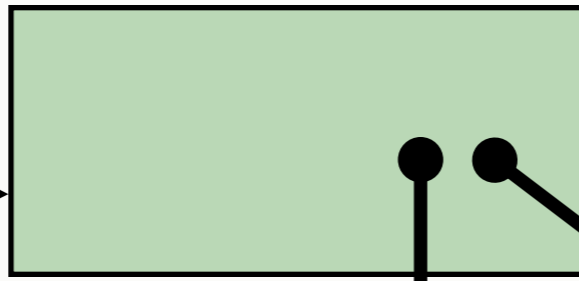

branch





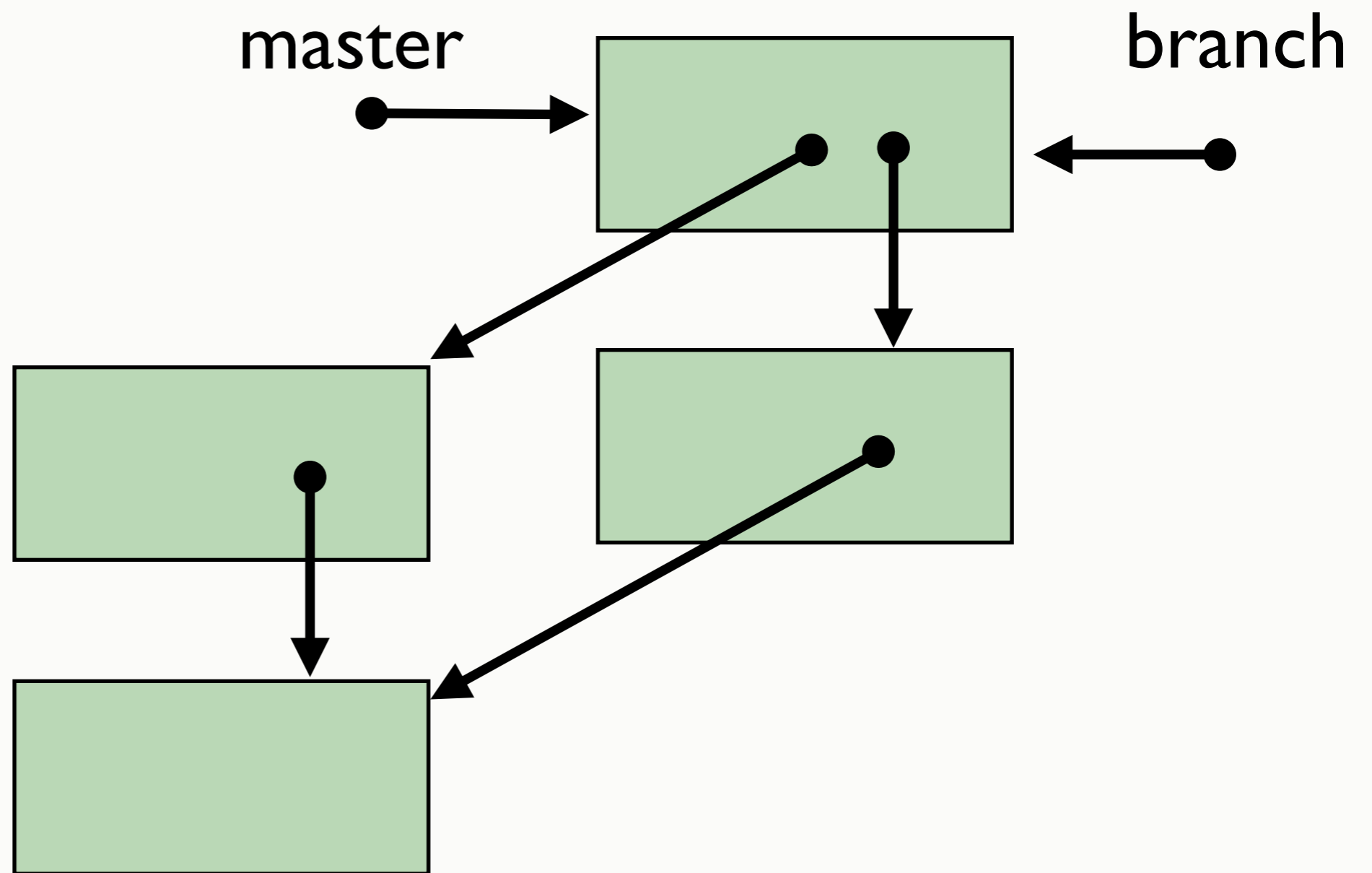

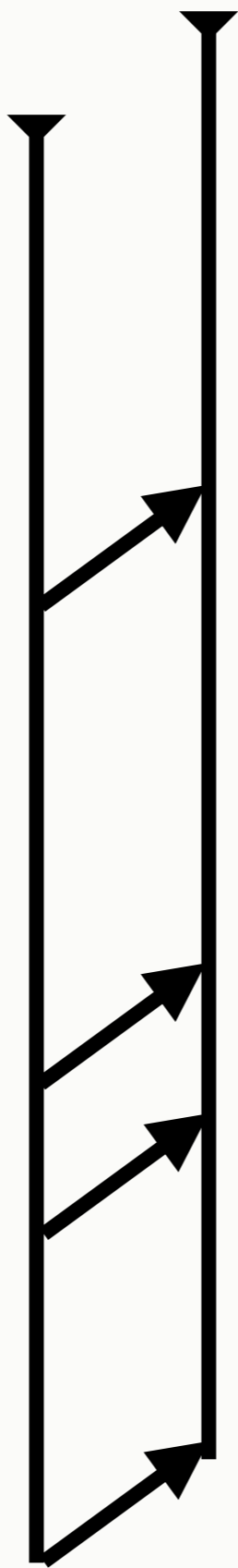

What happens when  
there is a conflict?

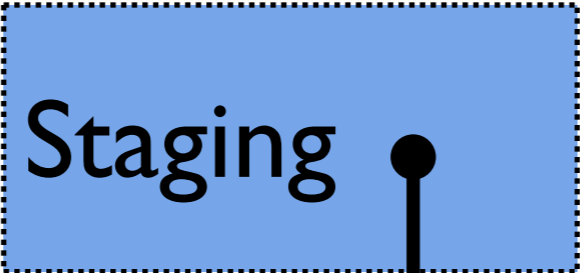

Working Directory

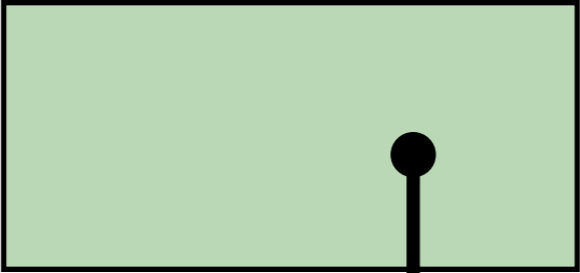

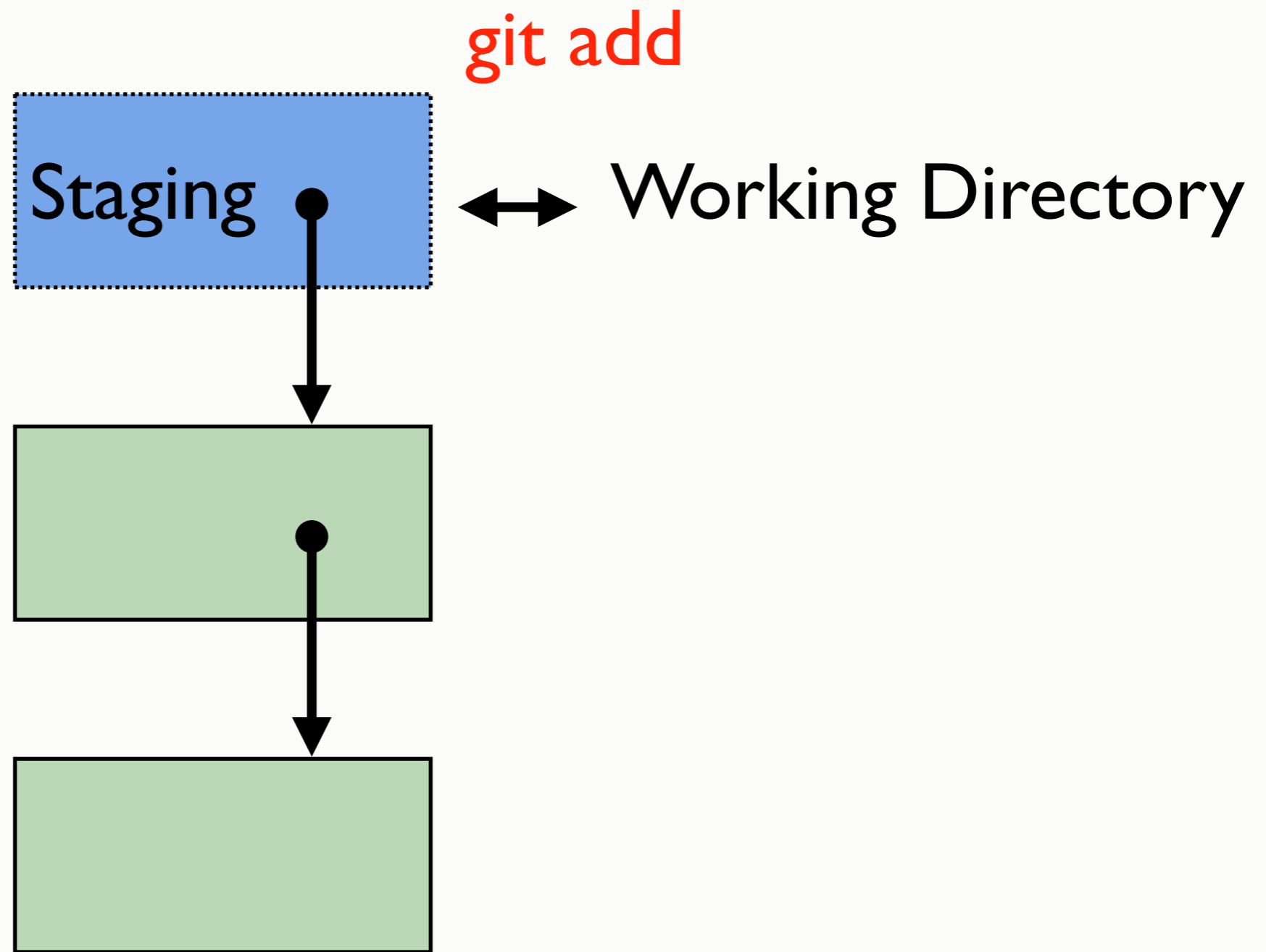



Working Directory

git commit

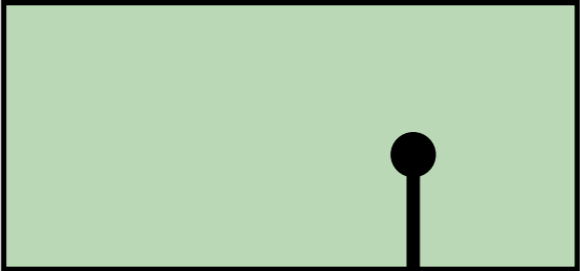
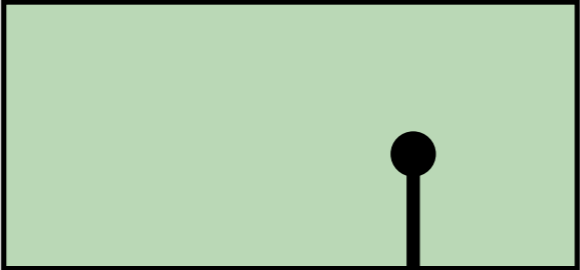

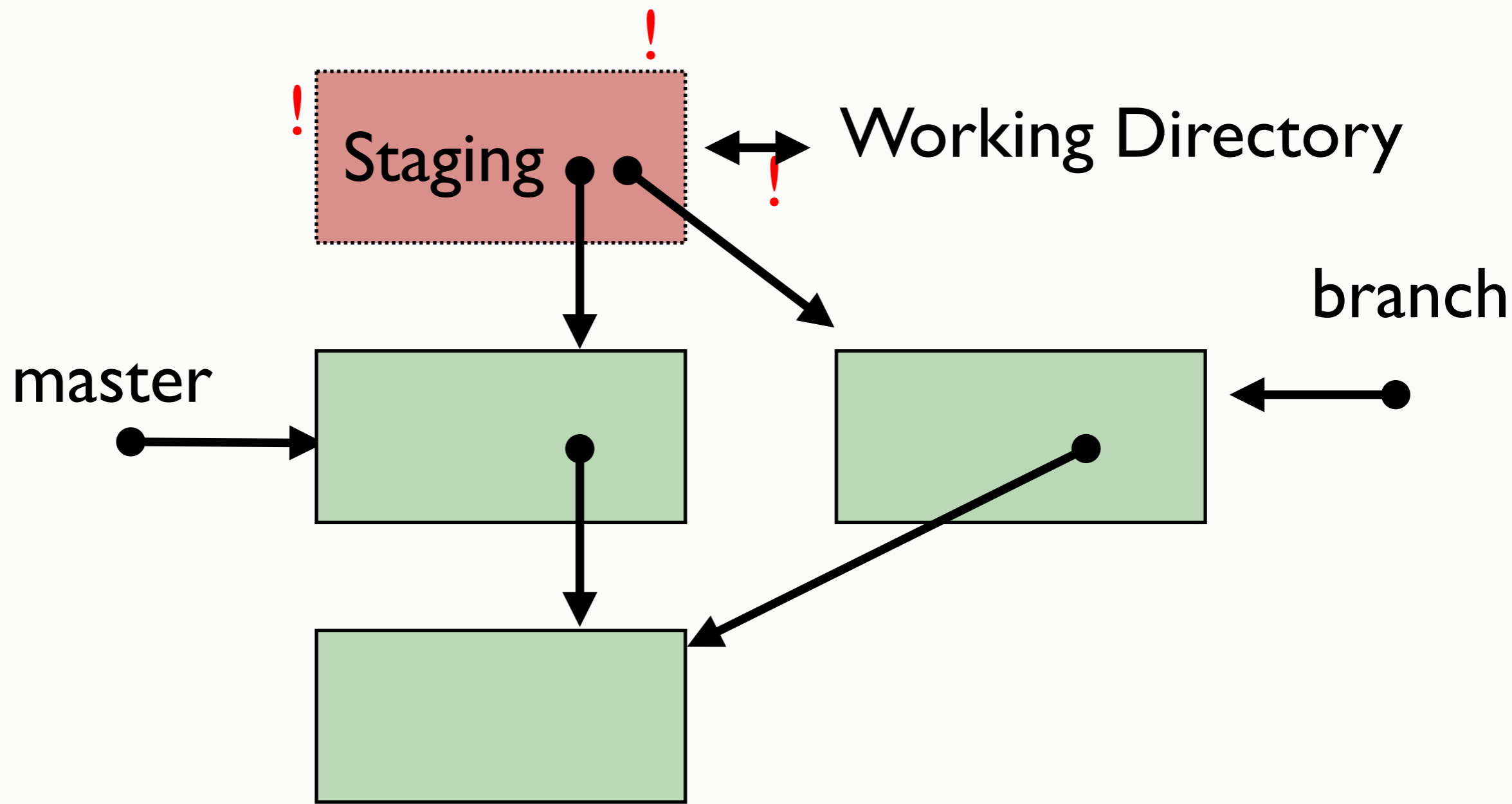

Should I pull or fetch  
and merge?



pull = fetch, merge

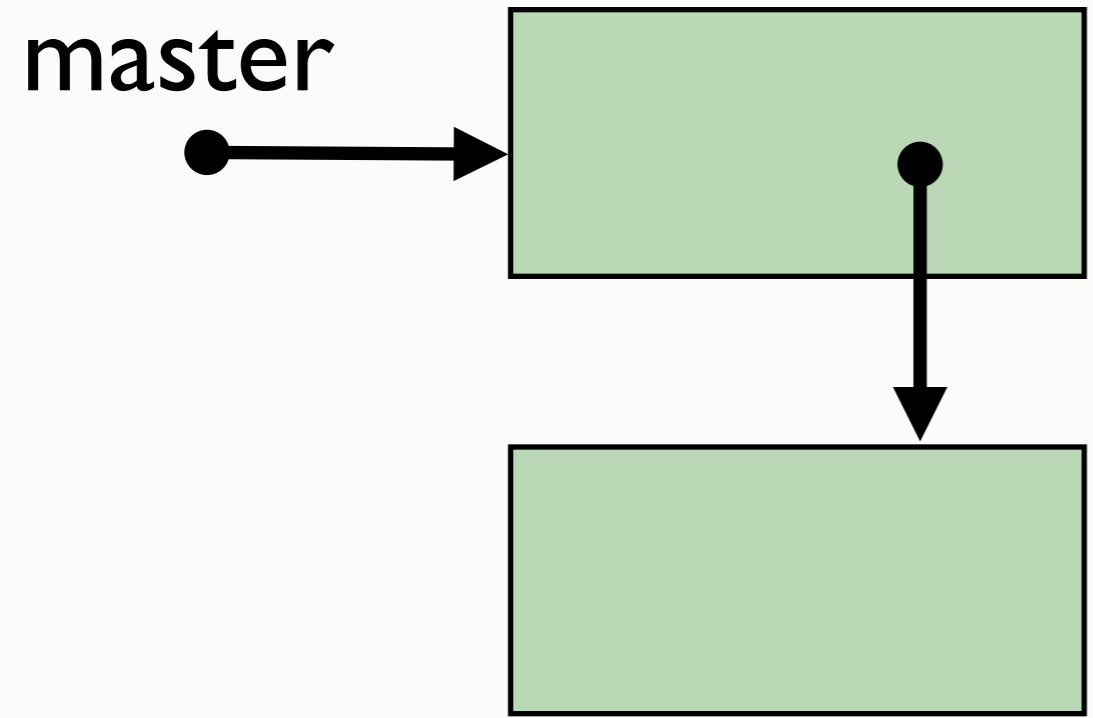

# Fetch

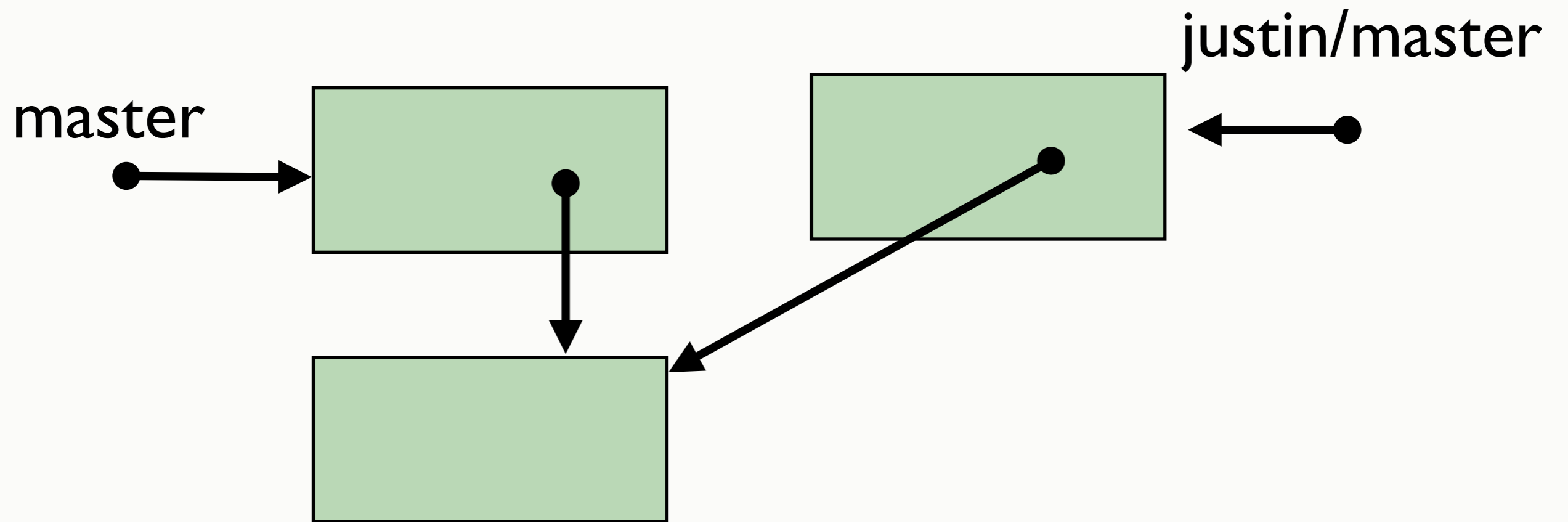

# Merge

master

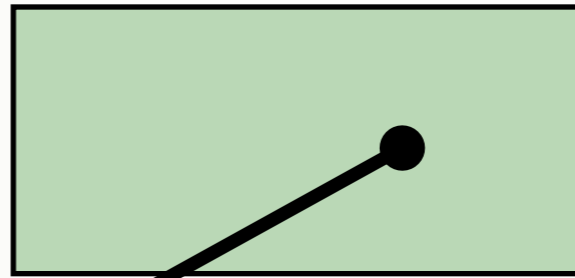
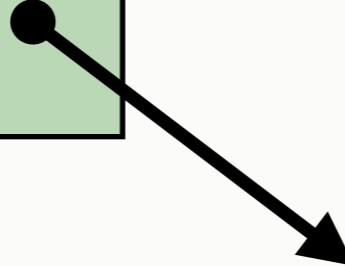
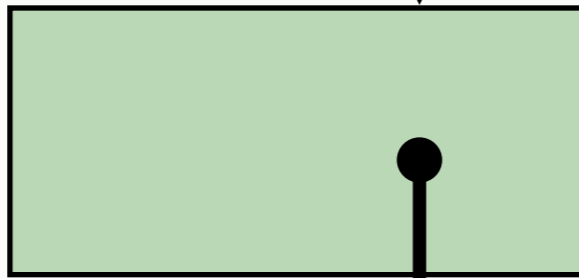
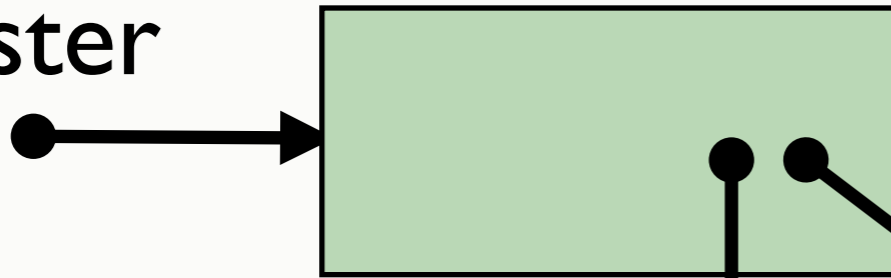

justin/master

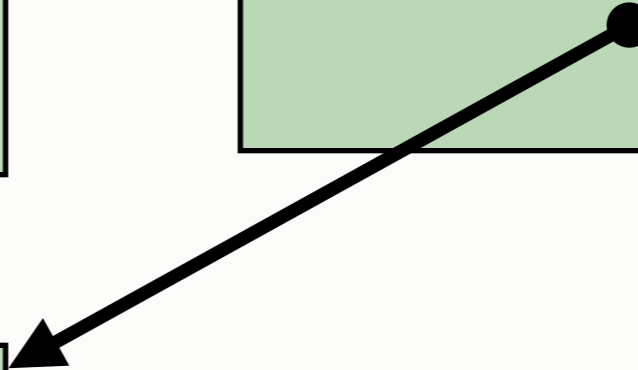

pull = fetch, merge

Do I rebase when I  
pull?

# Rebase

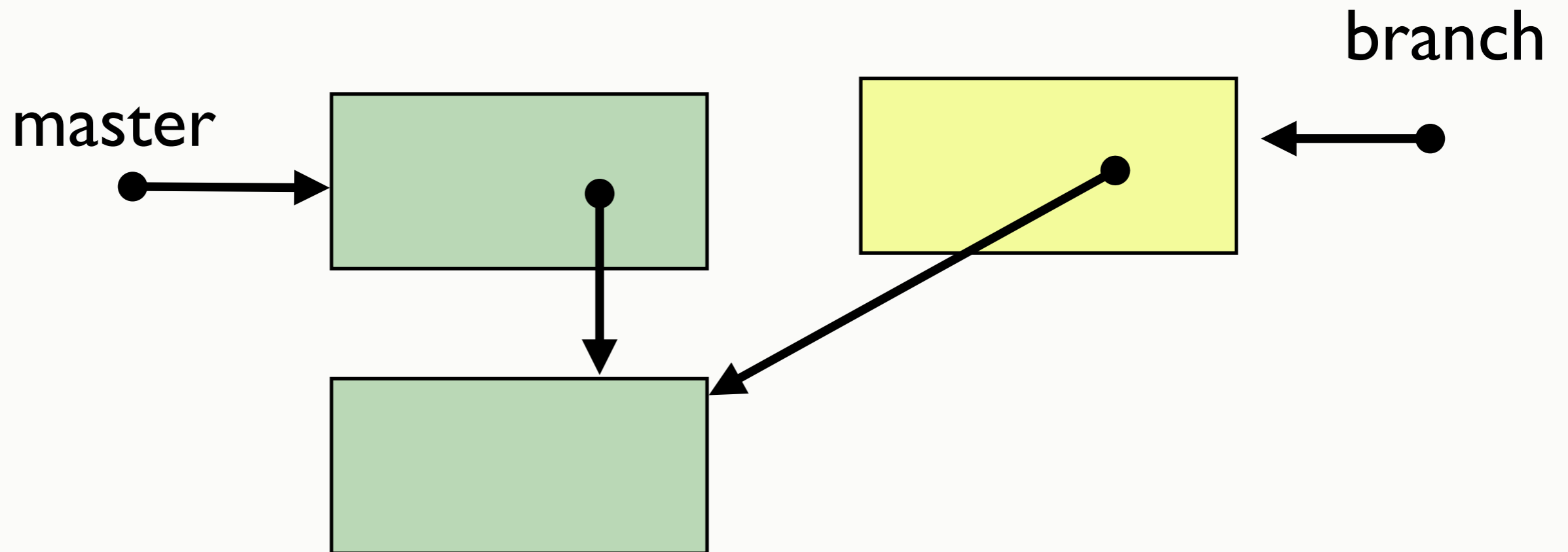

# Rebase

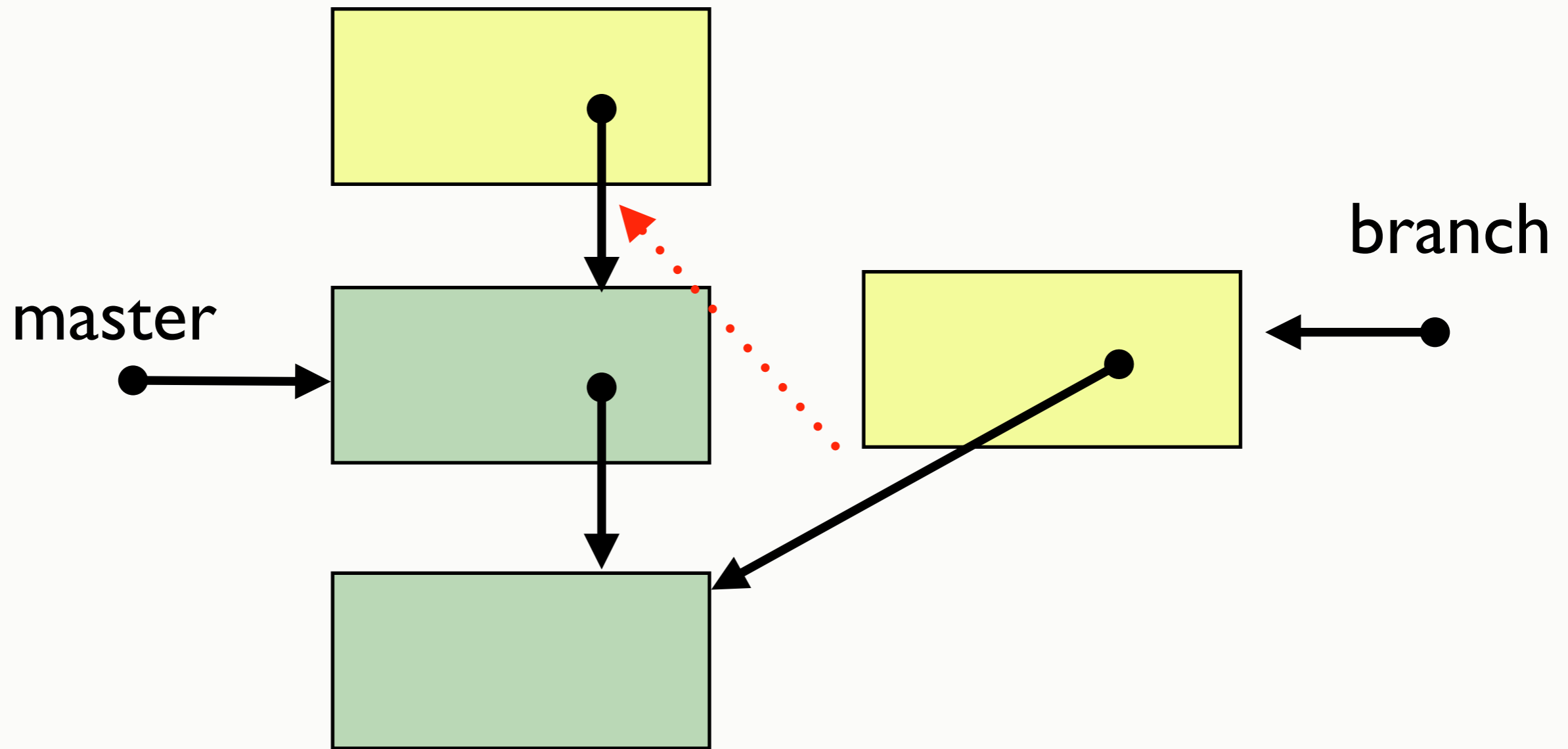



# Rebase

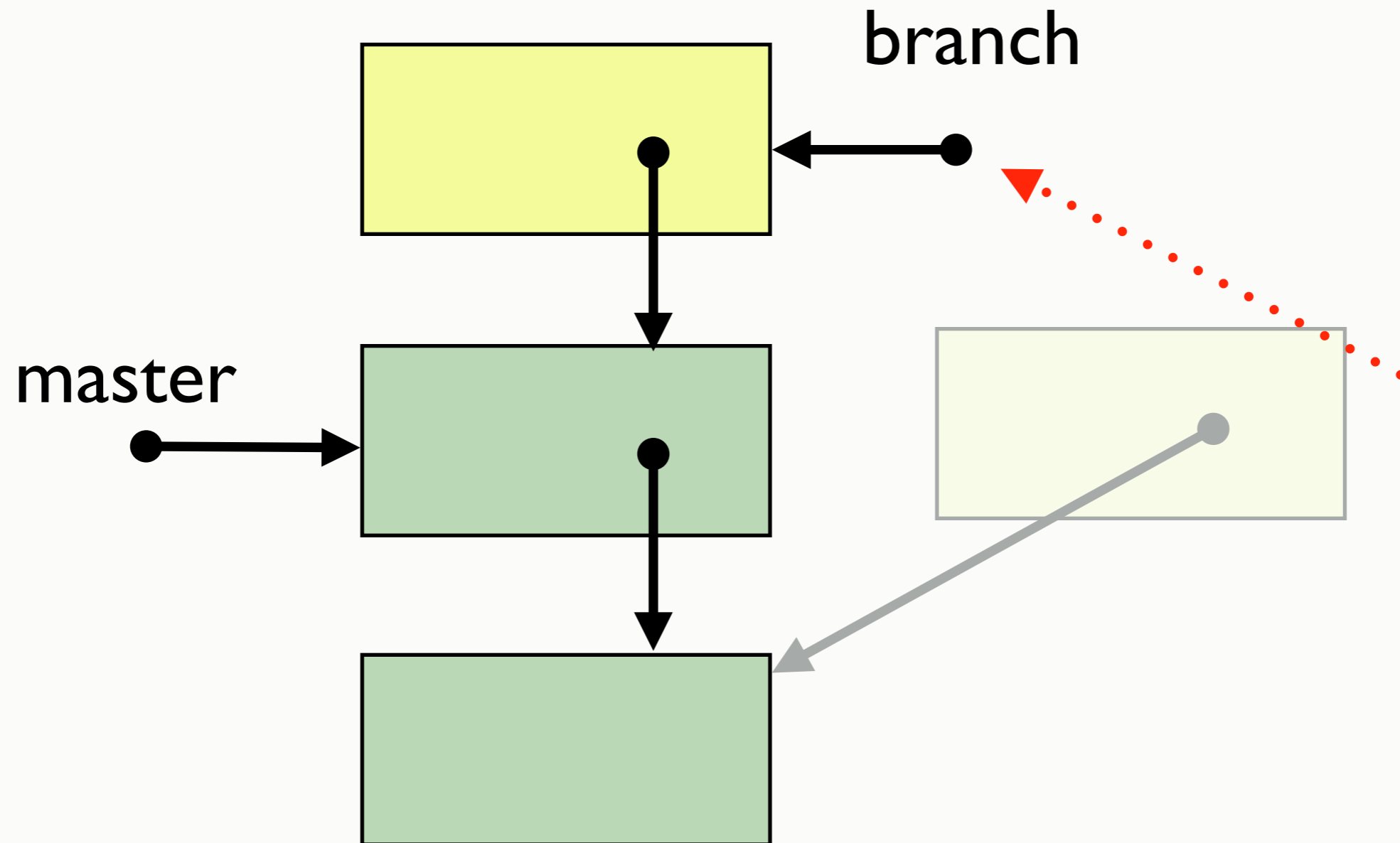

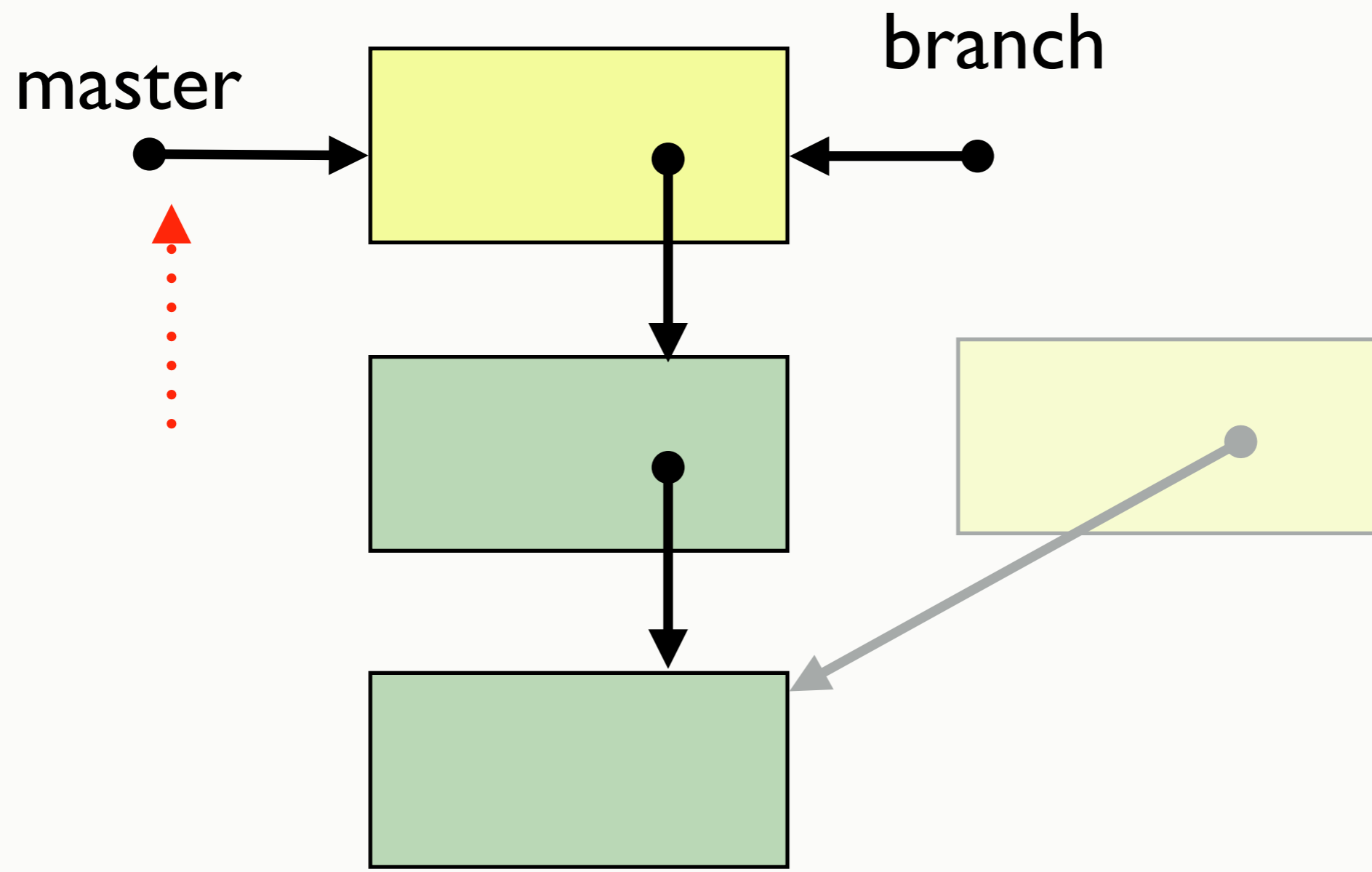

Do I rebase when I  
pull?

What's a pull  
request?



# git



# GitHub

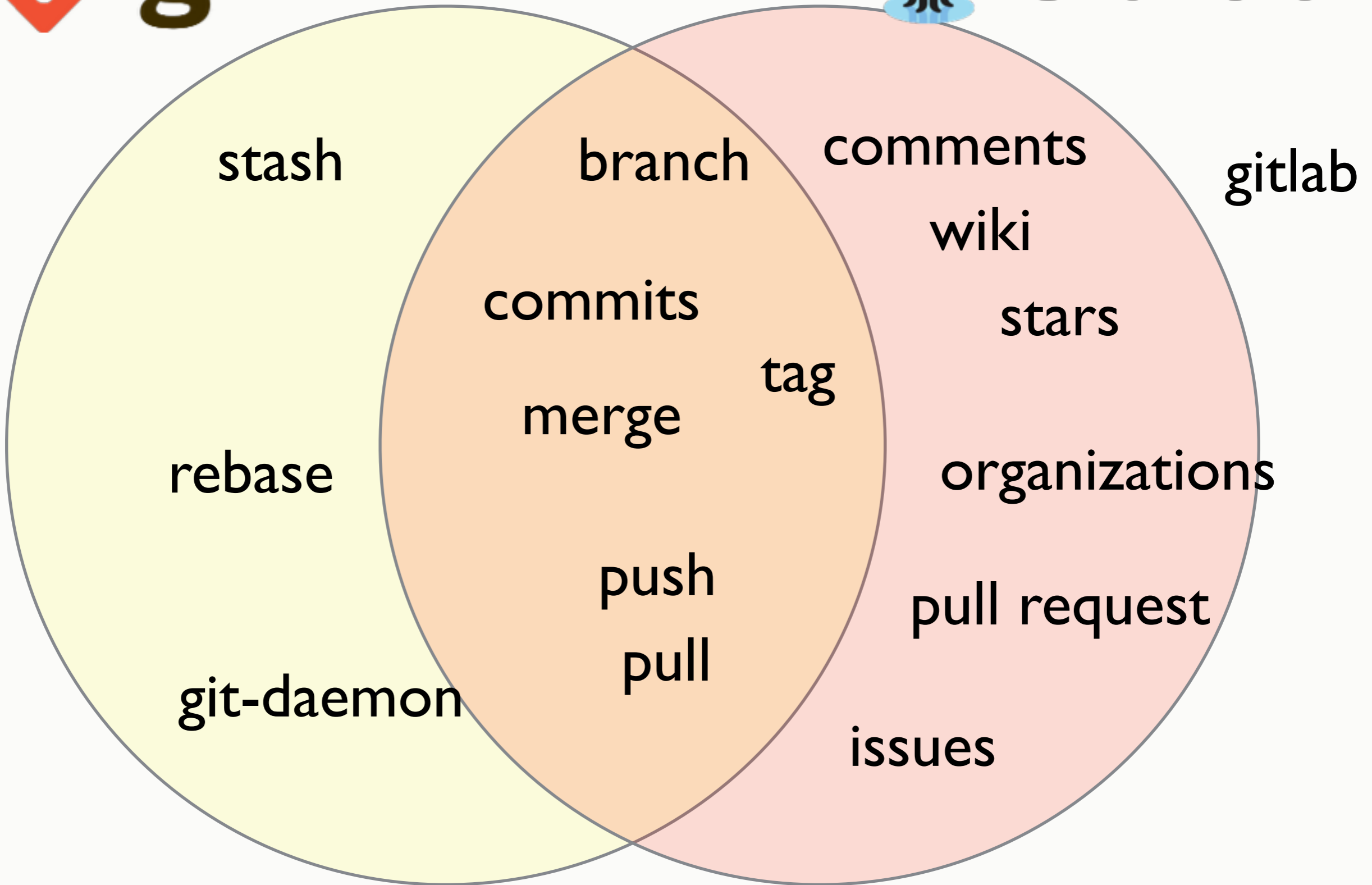

Write  
Access

Read  
Access

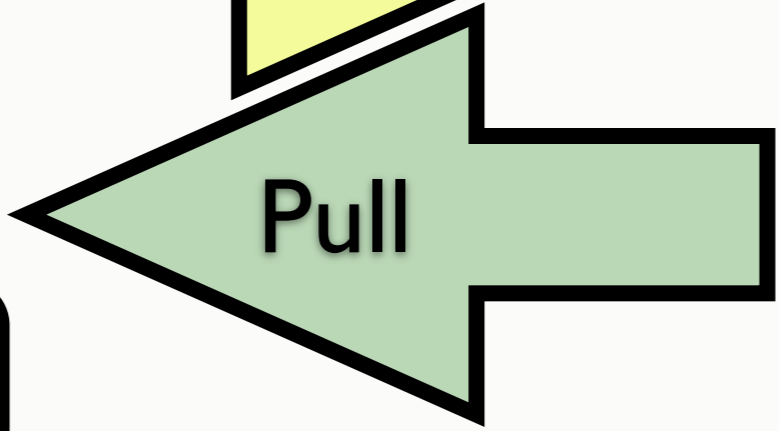
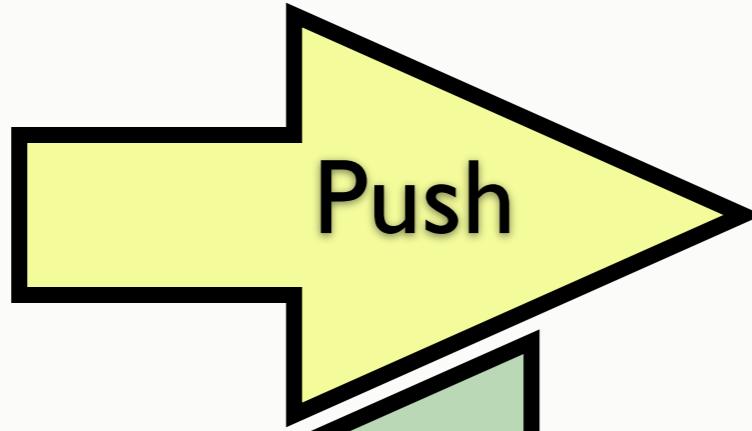

Your  
Repo

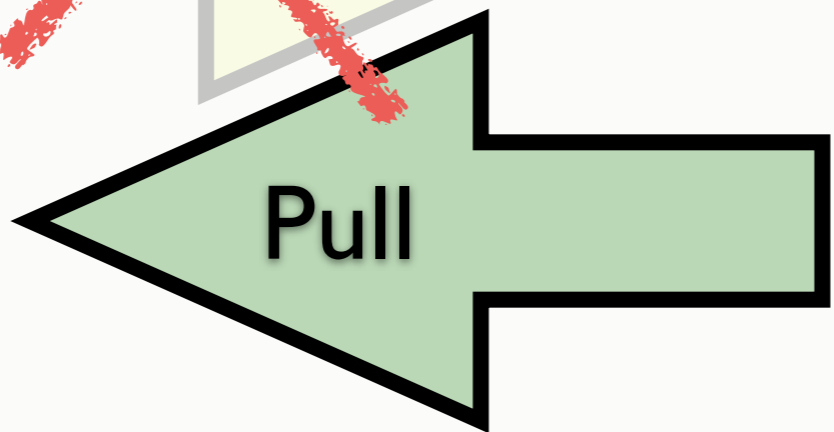
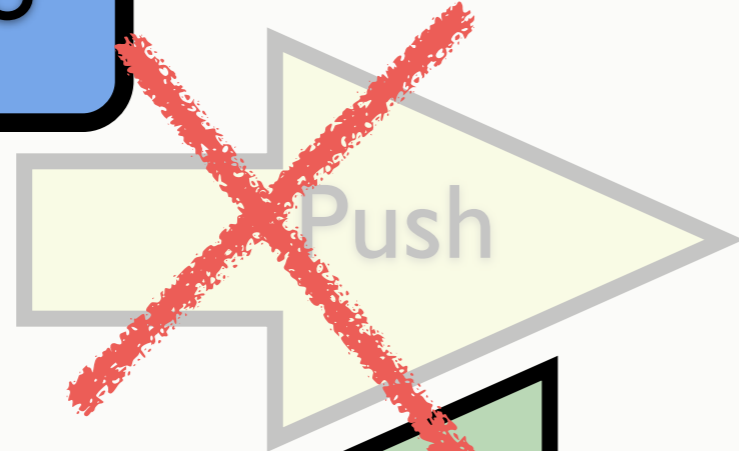

Your Repo

Please pull

Read Access

Pull

Okay

How do I make one?



Q & A

# Justin Love

[slides@wondible.com](mailto:slides@wondible.com)

<http://wondible.com>

@wondible

